

Componentes:

Contenido:

- | | |
|-------------------------------|---------------------------|
| 1. Techo (1) | 6. Freno Cubeta (1) |
| 2. Lateral Mano Derecha (1) | 7. Tope Cubeta (1) |
| 3. Lateral Mano Izquierda (1) | 8. Cubeta Ponedero (5) |
| 4. División Derecha (2) | 9. Tapadera de Cubeta (5) |
| 5. División Izquierda (2) | |

Bolsa de accesorios:

- Tornillo DIN 84 M5x8 (24)
 Tuerca DIN 934 M5 (24)
 Alcayata Roscada (4)
 Taco Nylon Ø8 mm. (4)

Herramientas Necesarias:

- Destornillador

Instrucciones de Montaje e Instalación:

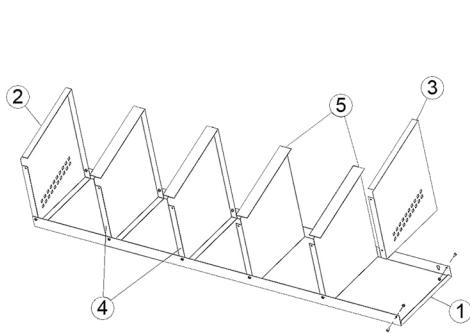

Fig.1
Sobre el techo, montar laterales y divisiones y atornillar según la Fig.1.

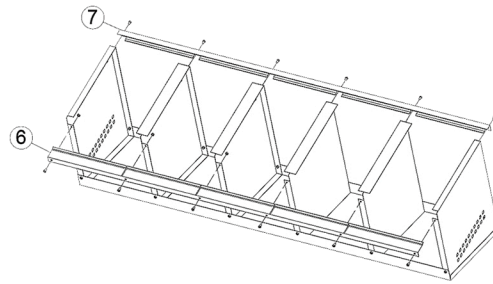

Fig.2
Colocar freno cubeta y tope cubeta según la Fig.2 y fijar con tornillos.

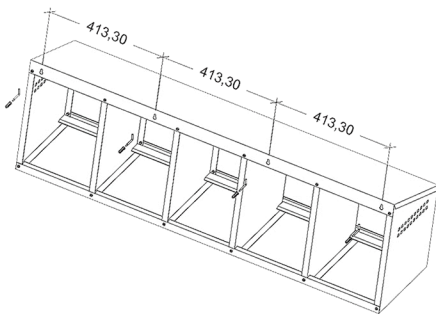

Fig.3
Marcar los agujeros usando el ponedero como plantilla.

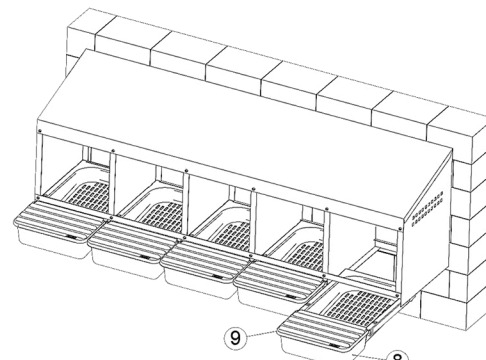

Fig.4
Colgar ponedero y colocar cubetas.



Component Parts:

Contents:

- | | |
|-------------------------|-----------------------|
| 1. Roof (1) | 6. Basket Brake (1) |
| 2. Right Side Panel (1) | 7. Basket Stop (1) |
| 3. Left Side Panel (1) | 8. Plastic Basket (5) |
| 4. Right Division (2) | 9. Basket Lid (5) |
| 5. Left Division (2) | |

Accessory Bag:

- Screw DIN 84 M5x8 (24)
 Nut DIN 934 M5 (24)
 Threaded Washer (4)
 Nylon Plug Ø8 mm. (4)

Tools Needed:

- Screwdriver

Assembly & Installation Instructions:

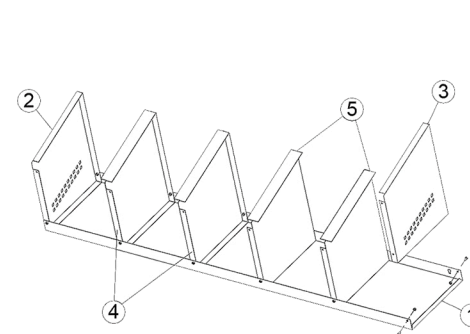

Fig.1
Fix the sides and partitions on the roof and screw according to the Fig.1.

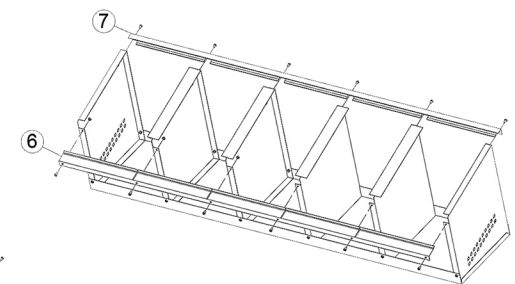

Fig.2
Mount the laying nest brake and the basket stopper according to the Fig.2 and fix with screws.

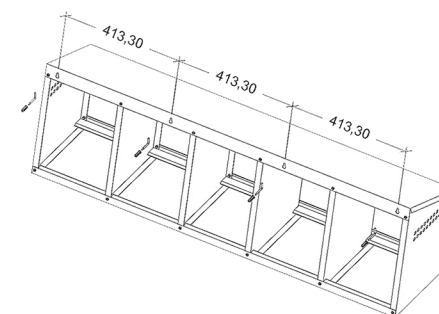

Fig.3
Mark the holes using the nest box as a template.

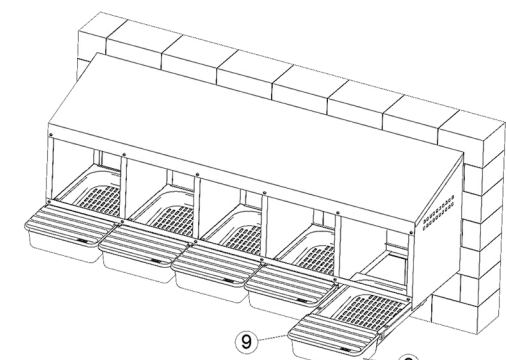

Fig.4
Hang the laying nest and place the baskets.



Composants:

Contenu:

- 1. Toit (1)
- 2. Panneau Lateral Droit (1)
- 3. Panneau Lateral Gauche (1)
- 4. Division Droite (2)
- 5. Division Gauche (2)
- 6. Frein Cuvette (1)
- 7. Stop Cuvette (1)
- 8. Cuvette Plastique (5)
- 9. Couverture de Cuvette (5)
- 1. Toit (1)
- 2. Panneau Lateral Droit (1)
- 3. Panneau Lateral Gauche (1)
- 4. Division Droite (2)
- 5. Division Gauche (2)

Sachet Accessoires:

- Vis DIN 84 M5x8 (24)
- Ecrou DIN 934 M5 (24)
- Rondelle Filétée (4)
- Cheville Nylon Ø8 mm. (4)

Outils Nécessaires:

- Tournevis

Instructions de Montage et D'Installation:

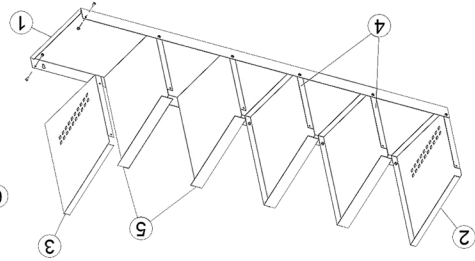

Fig.1
 Fixez les côtés et les cloisons sur le toit et vissez selon indiqué sur la Fig. 1.

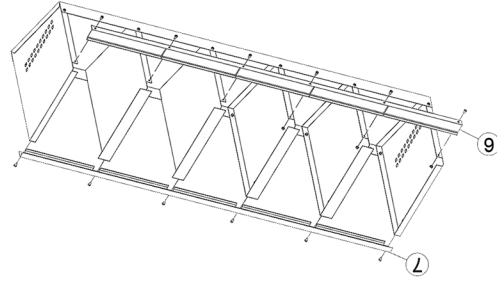

Fig.2
 Montez le frein du pondoir et le stop cuvette selon la Fig.2 et vissez.

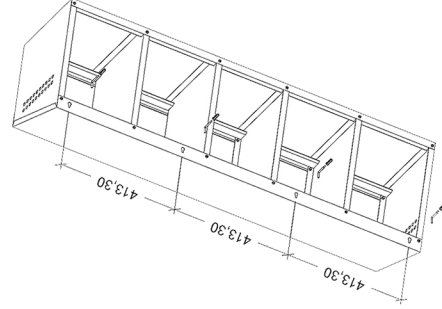

Fig.3
 Marquez les trous en utilisant le pondoir comme modèle.

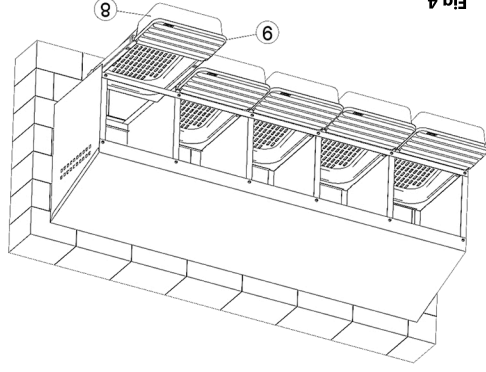

Fig.4
 Accrochez le pondoir et placez les cuvettes.



Komponenten:

Inhalt:

- 1. Dach (1)
- 2. Bodenbremse (1)
- 3. Bodenstopper (1)
- 4. Kunststoffboden (5)
- 5. Linke Seite (1)
- 6. Bodenbremse (1)
- 7. Bodenstopper (1)
- 8. Kunststoffboden (5)
- 9. Boden Deckel (5)
- 1. Dach (1)
- 2. Bodenbremse (1)
- 3. Bodenstopper (1)
- 4. Kunststoffboden (5)
- 5. Linke Abteilung (2)

Zubehörtsache:

- Schraube DIN 84 M5x8 (24)
- Schraubenmutter DIN 934 M5 (24)
- Schraubendreher
- Hakengewindstange (4)
- Kunststoffdübel Ø8 mm. (4)

Notwendige Werkzeuge:

Montage-und Installationsanleitung:

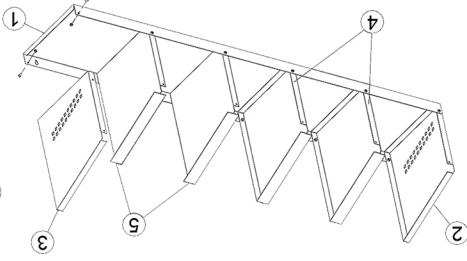

Fig.1
 Befestigen Sie die Seiten und Trennwände auf dem Dach und schrauben Sie sie wie in Fig.1 gezeigt.

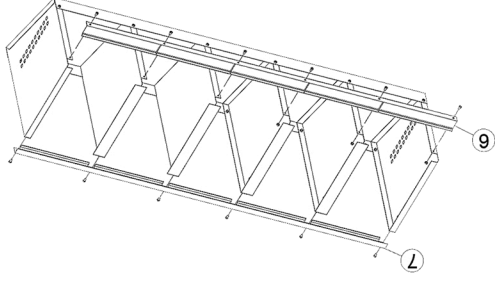

Fig.2
 Bodenbremse und Bodenstopper gemäß Fig.2 montieren und schrauben.

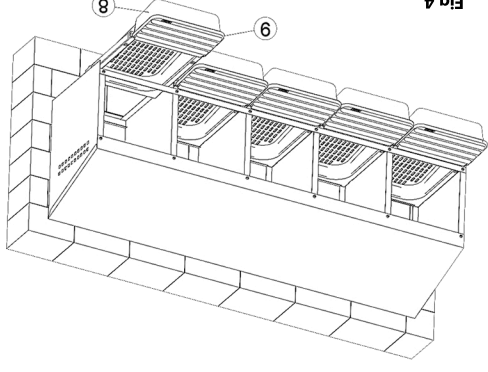

Fig.4
 Hängen Sie den Legenest auf und stellen Sie die Kunststoffboden auf.

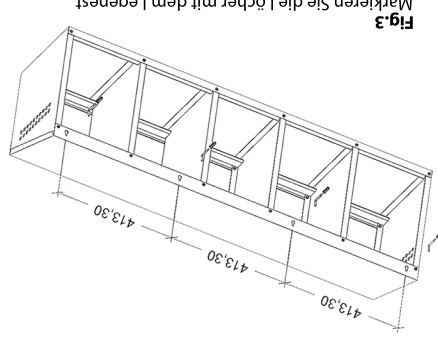

Fig.3
 Markieren Sie die Löcher mit dem Legenest als Vorlage.